

DESCRIPTION

The MP3425 is a current mode step-up converter with a 3.5A, 90mΩ internal switch to provide a highly efficient regulator with fast response. The MP3425 features a programmed frequency up to 2MHz allowing for easy filtering and low noise. An external compensation pin gives the user flexibility in setting loop dynamics, and operates with small, low-ESR ceramic output capacitors. Soft-start results in small inrush current and can be programmed with an external capacitor. The MP3425 operates from an input voltage as low as 3.1V and can generate 48V at up to 350mA from a 12V supply.

The MP3425 includes under-voltage lockout, current limiting and thermal overload protection to prevent damage in the event of an output overload. The MP3425 is available in a low profile 14-pin 3x4mm QFN package with exposed pad.

FEATURES

- 3.5A, 90mΩ, 55V Power MOSFET
- Uses Tiny Capacitors and Inductors
- Wide input range: 3.1V to 22V
- Output Voltage as High as 55V
- Programmable Fsw: 300kHz – 2 MHz
- Programmable UVLO, Soft-Start, UVLO Hysteresis
- Micropower shutdown <1μA
- Thermal Shutdown 160 °C
- Available in 14-Pin 3x4mm QFN Package

APPLICATIONS

- Telecom – Power Supply
- Audio - Microphone and Tuner Bias
- Automotive

All MPS parts are lead-free, halogen free, and adhere to the RoHS directive. For MPS green status, please visit MPS website under Quality Assurance.

"MPS" and "The Future of Analog IC Technology" are Registered Trademarks of Monolithic Power Systems, Inc.

TYPICAL APPLICATION

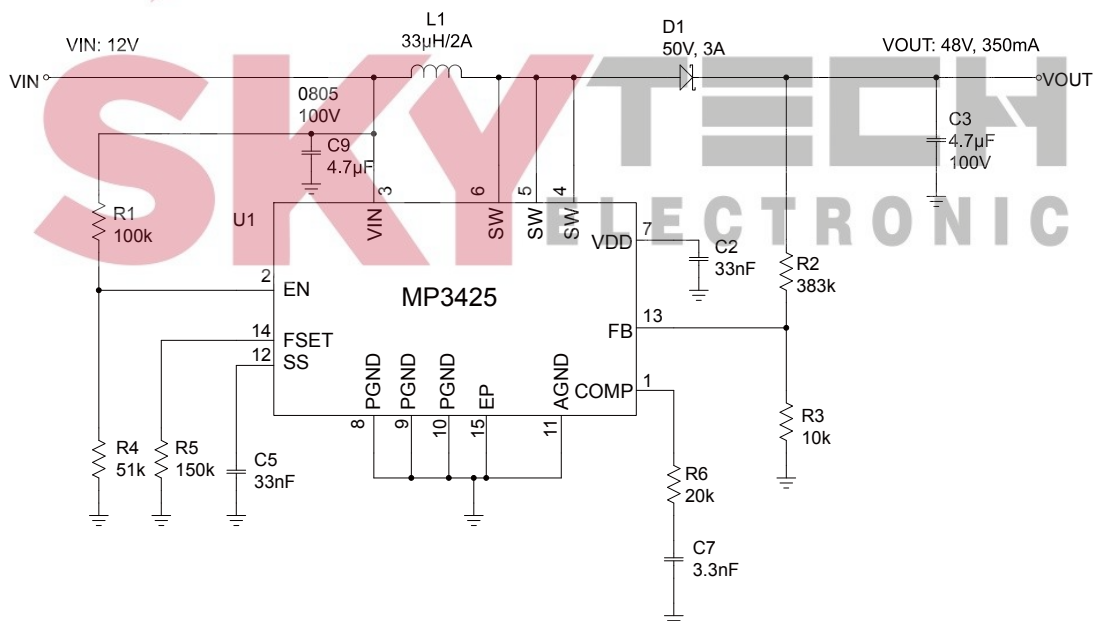

ORDERING INFORMATION

Part Number*	Package	Top Marking	Free Air Temperature (T _A)
MP3425DL	QFN-14 (3mmx4mm)	3425	-40°C to +85°C

* For Tape & Reel, add suffix -Z (e.g. MP3425DL-Z);
 For RoHS compliant packaging, add suffix -LF (e.g. MP3425DL-LF-Z)

PACKAGE REFERENCE

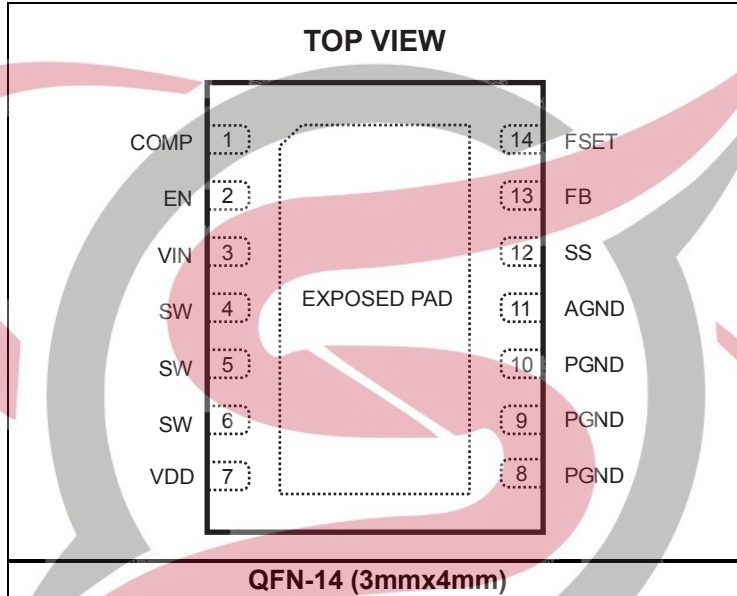

ABSOLUTE MAXIMUM RATINGS ⁽¹⁾

SW	-0.5V(-3V for 10ns) to +55V
IN	-0.5V to +22V
All Other Pins	-0.3V to +6.5V
Continuous Power Dissipation (T _A = +25°C) ⁽²⁾	
QFN14	2.5W
Junction Temperature	150°C
Lead Temperature	260°C
Storage Temperature	-65°C to +150°C

Recommended Operating Conditions ⁽³⁾

Supply Voltage V _{IN}	3.1V to 22V
Output Voltage V _{OUT}	3.1V to 55V
Operating Junct. Temp (T _J)	- 40°C to +125°C

Thermal Resistance	θ_{JA}	θ_{JC}
QFN-14 (3mmx4mm)	50	12 ... °C/W

Notes:

- Exceeding these ratings may damage the device.
- The maximum allowable power dissipation is a function of the maximum junction temperature T_J(MAX), the junction-to-ambient thermal resistance θ_{JA} , and the ambient temperature T_A. The maximum allowable continuous power dissipation at any ambient temperature is calculated by P_D(MAX)=(T_J(MAX)-T_A)/ θ_{JA} . Exceeding the maximum allowable power dissipation will cause excessive die temperature, and the regulator will go into thermal shutdown. Internal thermal shutdown circuitry protects the device from permanent damage.
- The device is not guaranteed to function outside of its operating conditions.

ELECTRICAL CHARACTERISTICS

$V_{IN} = V_{EN} = 5V$, $T_A = +25^{\circ}C$, unless otherwise noted.

Parameter	Symbol	Condition	Min	Typ	Max	Units
Operating Input Voltage	V_{IN}		3.1		22	V
Undervoltage Lockout		V_{IN} Rising	2.8		3.1	V
Undervoltage Lockout Hysteresis				250		mV
VDD Voltage Gate drive Voltage supply	V_{VDD}	$C = 10nF$			6	V
Supply Current (Shutdown)		$V_{EN} = 0V$			1	μA
Supply Current (Quiescent)		$V_{FB} = 1.35V$		650	900	μA
Switching Frequency		$F_{SET} = 84.5k\Omega$	0.44	0.55	0.66	MHz
Minimum Off time		$V_{FB} = 0V$		100		ns
Minimum On time		$V_{FB} = 1.35V$		100		ns
EN High Threshold		V_{EN} Rising (switching)	1.45	1.5	1.55	V
EN High Threshold		V_{EN} Rising (micro power)			1.0	V
EN Low Threshold			0.5			V
EN Input Bias Current		$V_{EN} = 0V, 5V$		0.1	1	μA
UVLO Hysteresis current into EN pin		$1.0 < EN < 1.4$		4		μA
Soft-Start Current				5		μA
FB Voltage			1.200	1.225	1.250	V
FB Input Bias Current			-200	-100		nA
Error Amp Voltage Gain	A_{VEA}			300		V/V
Error Amp Transconductance ($\frac{\mu A}{V}$)	G_{EA}			160		$\mu A/V$
Error Amp Output Current				20		μA
GCS : $I(SW) / V_{comp}$	G_{CS}			9		A/V
SW On-Resistance	R_{ON}			90		m Ω
SW Current Limit		Duty Cycle = 0%	3.5	5		A
Thermal Shutdown				160		$^{\circ}C$

SKYTECH
ELECTRONIC

PIN FUNCTIONS

QFN14 Pin #	Name	Description
1	COMP	Compensation Pin. Connect a capacitor and resistor in series to Analog ground for loop stability.
2	EN	Regulator On/Off Control Input. A high input at EN turns on the converter, and a low input turns it off. When not used, connect EN to the input source (through a 100kΩ pull-up resistor if $V_{IN} > 6V$) for automatic startup. EN pin can also be used to program Vin UVLO. EN cannot be left floating.
3	VIN	Input Supply Pin. IN must be locally bypassed.
4, 5, 6	SW	Power Switch Output. SW is the drain of the internal MOSFET switch. Connect the power inductor and output rectifier to SW.
7	VDD	LDO Output
8, 9, 10, Exposed Pad	PGND	The bottom exposed pad is the power ground. For best thermal resistance, solder the exposed pad to underlying copper backplane
11	AGND	Analog Ground. Connect to ground plane through exposed pad.
12	SS	Soft-Start Control Pin. Connect a soft-start capacitor to this pin. The soft-start capacitor is charged with a constant current of 5μA. Leave SS disconnected if the soft-start is not used.
13	FB	Feedback Input. Reference voltage is 1.225V. Connect a resistor divider this pin.
14	FSET	Frequency Programming Pin. Connect a resistor from this pin to AGND. FSET pin voltage is internally regulated to 0.5V. The current flowing out of this pin linearly sets the operation frequency.
15	EP	Exposed Pad. The bottom exposed pad is the power ground. For best thermal resistance, solder the exposed pad to underlying cooper backplane.



TYPICAL PERFORMANCE CHARACTERISTICS

$V_{IN}=12V$, $V_{OUT}=48V$, $L=33\mu H$, $C_{OUT}=4.7\mu F$, $f_{SW}=300kHz$, $T_A=+25^\circ C$, unless otherwise noted.

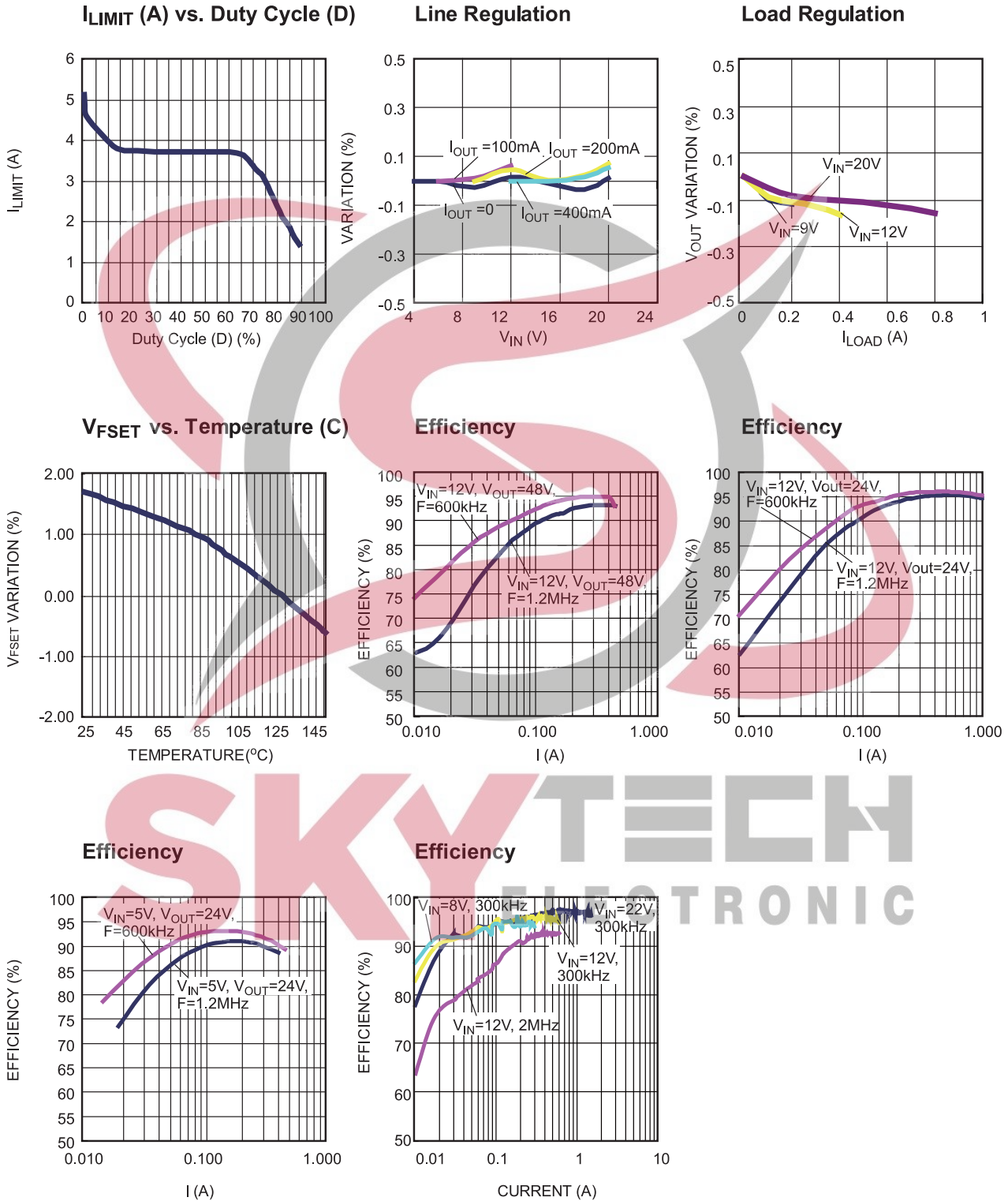

TYPICAL PERFORMANCE CHARACTERISTICS *(continued)*

$V_{IN}=12V$, $V_{OUT}=48V$, $L=33\mu H$, $C_{OUT}=4.7\mu F$, $f_{SW}=300kHz$, $T_A=+25^\circ C$, unless otherwise noted.

V_{OUT} Ripple

$V_{IN} = 12V$, $V_{OUT} = 48V$,
 $I_{OUT} = 400mA$

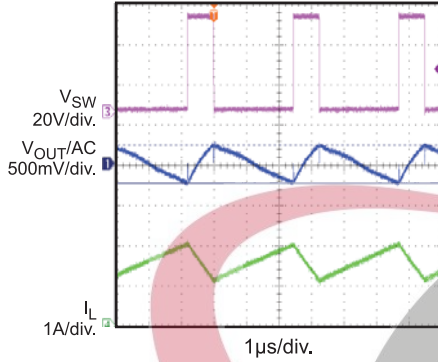

Transient Response

$V_{IN} = 12V$, $V_{OUT} = 48V$,
200mA-400mA Step

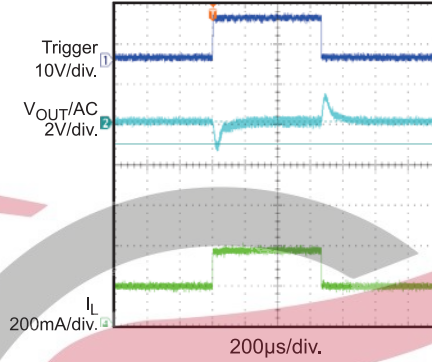

25°C- V_{OUT} , V_{SS} , V_{SW} , I_L No/Full Load

$V_{IN} = 12V$, Load=400mA

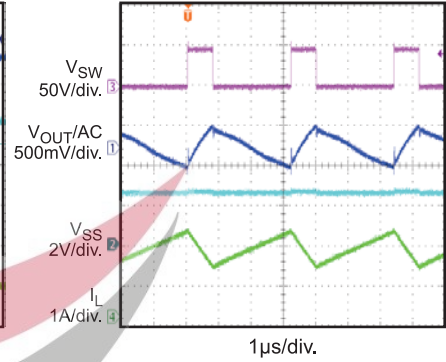

EN Start-Up

$V_{IN} = 12V$, Load=0A

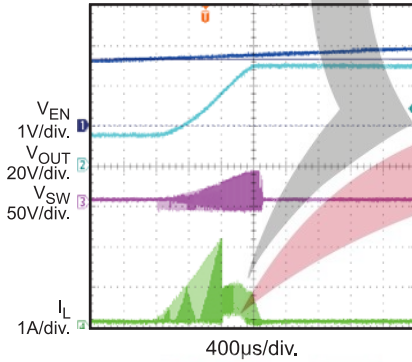

EN Start-Up

$V_{IN} = 12V$, Load=400mA

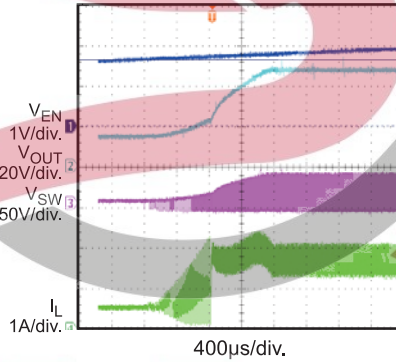

EN Shutdown

$V_{IN} = 12V$, Load=0A

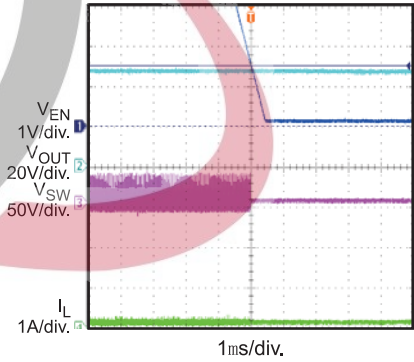

EN Shutdown

$V_{IN} = 12V$, Load=400mA

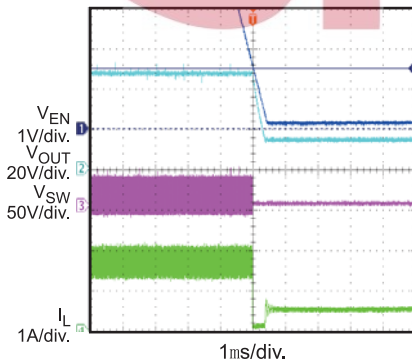

V_{IN} Start-Up

$V_{IN} = 12V$, Load=0A

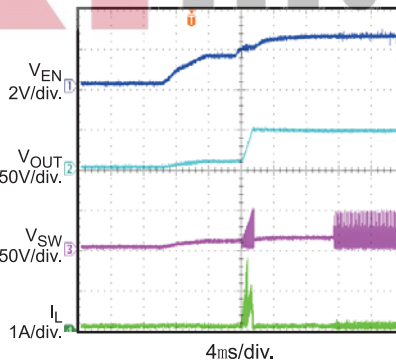

V_{IN} Start-Up

$V_{IN} = 12V$, Load=400mA

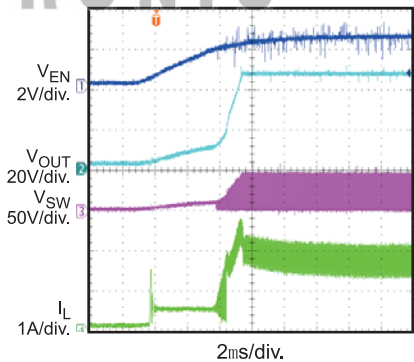

TYPICAL PERFORMANCE CHARACTERISTICS *(continued)*

$V_{IN}=12V$, $V_{OUT}=48V$, $L=33\mu H$, $C_{OUT}=4.7\mu F$, $f_{SW}=300kHz$, $T_A=+25^\circ C$, unless otherwise noted.

Vin Shutdown

$V_{IN} = 12V$, Load = 0A

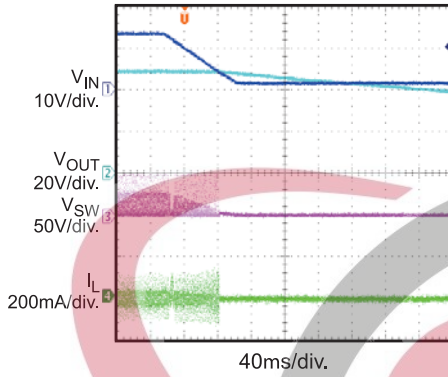

Vin Shutdown

$V_{IN} = 12V$, Load = 400mA

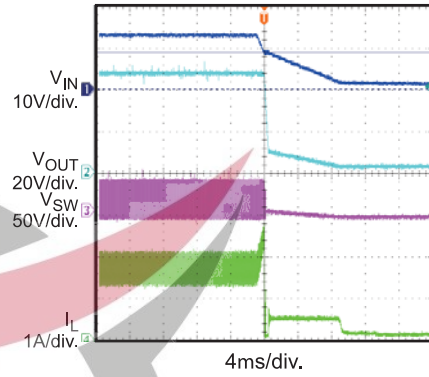

BLOCK DIAGRAM

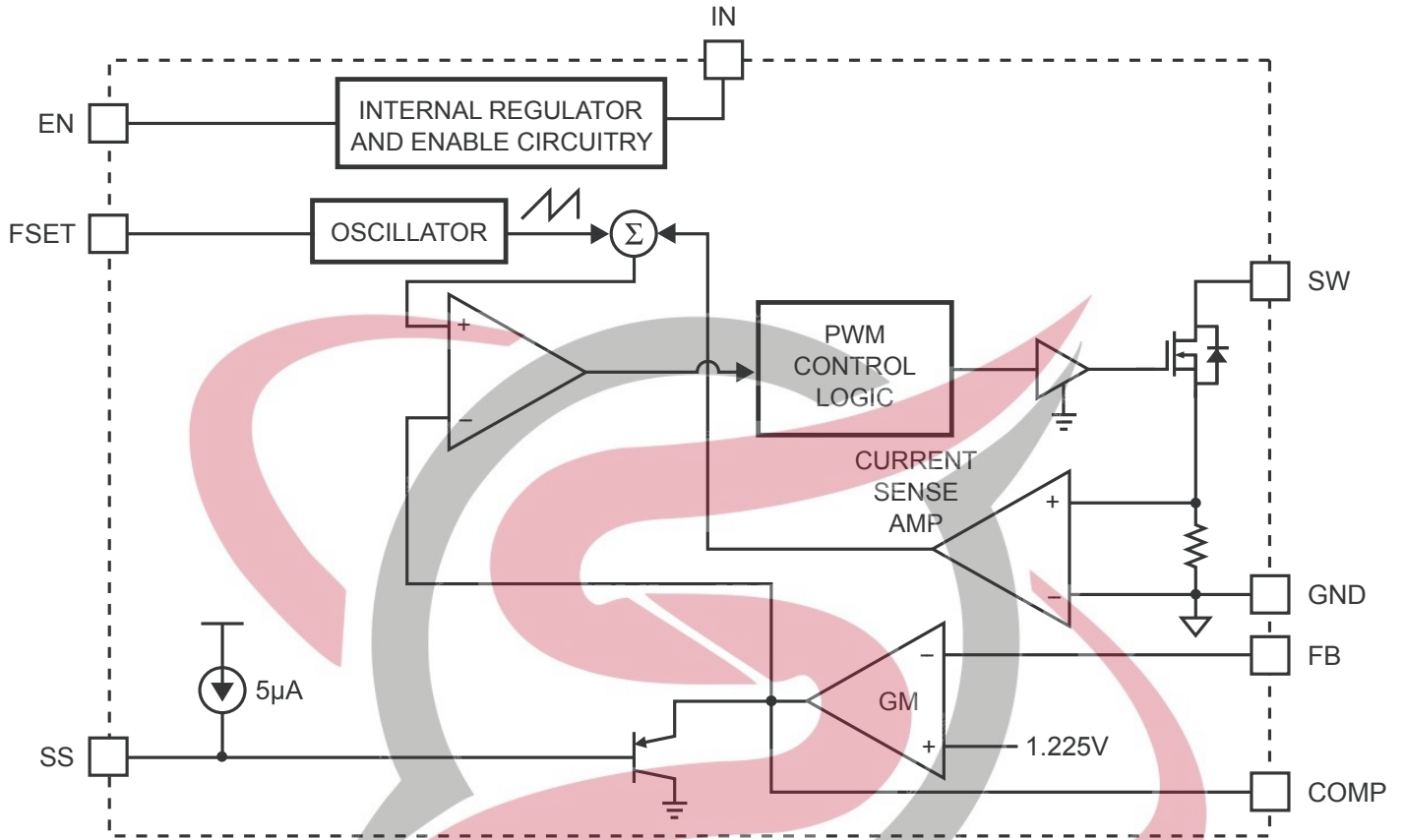

Figure 1—Function Block Diagram



APPLICATION INFORMATION

Components referenced below apply to the “Typical Application Circuit”.

Theory of Operation

The MP3425 uses a constant frequency, peak current mode boost regulation architecture to regulate the feedback voltage. The operation of the MP3425 can be understood by referring to the block diagram of Functional.

At the beginning of each cycle, the N-Channel MOSFET switch is turned on, forcing the inductor current to rise. The current at the source of the switch is internally measured and converted to a voltage by the current sense amplifier. That voltage is compared to the error voltage at comp. The voltage at the output of the error amplifier is an amplified version of the difference between the 1.225V reference voltage and the feedback voltage.

When these two voltages are equal, the PWM comparator turns off the switch forcing the inductor current to the output capacitor through the external rectifier. This causes the inductor current to decrease. The peak inductor current is controlled by the voltage at COMP, which in turn is controlled by the output voltage. Thus the output voltage is regulated by the inductor current to satisfy the load. The use of current mode regulation improves the transient response and control loop stability.

Selecting the Switching Frequency

The switching frequency is set by R5. The equation is:

$$F_{SET} = 23 \times (R5^{-0.86})$$

Where R5 is in kΩ, F_{SET} is in MHz.

UVLO Hysteresis

The MP3425 features a programmable UVLO hysteresis. Upon power up a 4μA current sink is applied to the resistor divider attached to the EN pin. This means that on power up VIN must increase by an extra amount to overcome the current sink. That extra amount is the current sink times the resistor from VIN to EN. Once the EN pin reaches about 1.5V the current sink will turn off to create the reverse hysteresis for VIN falling:

$$UVLO_{Hysteresis} = 4\mu A \times R_{TOP}$$

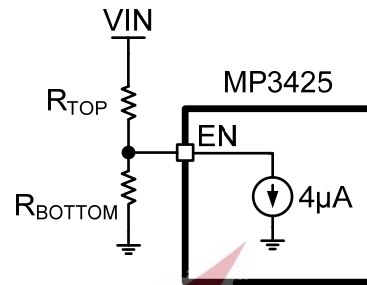

Table1—Frequency Selection

R5 (kΩ)	Freq (MHz)
180	0.26
160	0.29
150	0.31
143	0.32
66.5	0.62
35.7	1.06
25	1.44
18	1.91
16	2.12
14	2.37

Selecting the Soft-Start Capacitor

The MP3425 includes a soft-start timer that limits the voltage at COMP during startup to prevent excessive current at the input. This prevents premature termination of the source voltage at startup due to input current overshoot. When power is applied to the MP3425, and enable is asserted, a 5μA internal current source charges the external capacitor at SS. As the SS capacitor is charged, the voltage at SS rises. When the SS voltage reaches 250mV, the MP3425 starts switching at ¼ of the programmed frequency (frequency fold back mode). At 800mV the switching frequency becomes the programmed value. The soft-start ends when the voltage at SS reaches 2.5V. This limits the inductor current at start-up, forcing the input current to rise slowly to the current required to regulate the output voltage.

The soft-start period is determined by the equation:

$$t_{ss} = \frac{C_{SS} \times 10^{-9} \times 2.5V}{5\mu A}$$

Where C_{SS} (nF) is the soft-start capacitor from SS to GND, and t_{ss} is the soft-start period.

Setting the Output Voltage

This is the actual output voltage. It is fed back through two sense resistors in series. The feedback voltage is 1.225V typical. The equation to the output voltage is:

$$V_{OUT} = V_{REF} \times \left(1 + \frac{R2}{R3}\right)$$

Where:

R2 is the top feedback resistor

R3 in the bottom feedback resistor

V_{REF} is the reference voltage (1.225V typical)

Choose the feedback resistors to be in the 10k or higher range for good efficiency.

Selecting the Input Capacitor

An input capacitor is required to supply the AC ripple current to the inductor, while limiting noise at the input source. A low ESR capacitor is required to keep the noise at the IC to a minimum. Ceramic capacitors are preferred, but tantalum or low-ESR electrolytic capacitors may also suffice.

Use an input capacitor value greater than 4.7µF. The capacitor can be electrolytic, tantalum or ceramic. However since it absorbs the input switching current it requires an adequate ripple current rating. Use a capacitor with a RMS current rating greater than the inductor ripple current (see “Selecting The Inductor” to determine the inductor ripple current).

To insure stable operation place the input capacitor as close to the IC as possible. Alternately a smaller high quality ceramic 0.1 µF capacitor may be placed closer to the IC with the larger capacitor placed further away. If using this technique, it is recommended that the larger capacitor be a tantalum or electrolytic type. All ceramic capacitors should be placed close to the MP3425.

Selecting the Output Capacitor

The output capacitor is required to maintain the DC output voltage. Low ESR capacitors are preferred to keep the output voltage ripple to a minimum. The characteristic of the output capacitor also affects the stability of the regulation control system. Ceramic, tantalum, or low ESR electrolytic capacitors are recommended. In the case of ceramic capacitors, the impedance of the capacitor at the switching frequency is dominated by the capacitance, and so the output voltage ripple is mostly independent of the ESR. The output voltage ripple is estimated to be:

$$V_{RIPPLE} \cong \frac{\left(1 - \frac{V_{IN}}{V_{OUT}}\right) \times I_{LOAD}}{C_{OUT} \times F_{SW}}$$

Where V_{ripple} is the output ripple voltage, V_{in} and V_{out} are the DC input and output voltages respectively, I_{load} is the load current, F_{sw} is the switching frequency, and C_{OUT} is the capacitance of the output capacitor.

In the case of tantalum or low-ESR electrolytic capacitors, the ESR dominates the impedance at the switching frequency, and so the output ripple is calculated as:

$$V_{RIPPLE} \cong \frac{\left(1 - \frac{V_{IN}}{V_{OUT}}\right) \times I_{LOAD}}{C_{OUT} \times F_{SW}} + \frac{I_{LOAD} \times R_{ESR} \times V_{OUT}}{V_{IN}}$$

Where R_{ESR} is the equivalent series resistance of the output capacitors.

Choose an output capacitor to satisfy the output ripple and load transient requirements of the design. A 4.7µF – 22µF ceramic capacitor is suitable for most applications.

Selecting the Inductor

The inductor is required to force the higher output voltage while being driven by the input voltage. A larger value inductor results in less ripple current that results in lower peak inductor current, reducing stress on the internal N-Channel switch. However, the larger value inductor has a larger physical size, higher series resistance, and/or lower saturations current.

A good rule of thumb is to allow the peak-to-peak ripple current to be approximately 30-50% of the maximum input current. Make sure that the peak inductor current is below 75% of the current limit at the operating duty cycle to prevent loss of regulation due to the current limit. Also make sure that the inductor does not saturate under the worst-case load transient and startup conditions. Calculate the required inductance value by the equation:

$$L = \frac{V_{IN} \times (V_{OUT} - V_{IN})}{V_{OUT} \times F_{SW} \times \Delta I}$$

$$I_{IN(max)} = \frac{V_{OUT} \times I_{LOAD(MAX)}}{V_{IN} \times \eta}$$

Where :
 $I_{LOAD(max)}$ is the maximum load current
 ΔI is the peak-to-peak inductor ripple current
 $\Delta I = (30\% - 50\%) \times I_{IN(MAX)}$
 η is efficiency.

Selecting the Diode

The output rectifier diode supplies current to the inductor when the internal MOSFET is off. To reduce losses due to diode forward voltage and recovery time, use a Schottky diode with the MP3425. The diode should be treated for a reverse voltage equal to or greater than the output voltage used. The average current rating must be greater than the maximum load current expected, and the peak current rating must be greater than the peak inductor current.

Compensation

The output of the transconductance error amplifier (COMP) is used to compensate the regulation control system. The system uses two poles and one zero to stabilize the control loop. The poles are F_{P1} set by the output capacitor C_{OUT} and the load resistance, and f_{P2} start from origin, the zero f_{z1} set by the compensation capacitor C_{COMP} and the compensation resistor R_{COMP} . These are determined by the equations:

$$F_{P1} = \frac{1}{2 \times \Pi \times R_{LOAD} \times C_{OUT}} \text{ (Hz)}$$

$$F_{P2} = \frac{G_{EA}}{2 \times \Pi \times A_{VEA} \times C_{COMP}} \text{ (Hz)}$$

$$F_{Z1} = \frac{1}{2 \times \Pi \times R_{COMP} \times C_{COMP}} \text{ (Hz)}$$

Where R_{LOAD} is the load resistance, G_{EA} is the error amplifier transconductance, and A_{VEA} is the error amplifier voltage gain.

The DC loop gain is

$$A_{VDC} = \frac{A_{VEA} \times V_{IN} \times R_{LOAD} \times V_{FB} \times G_{CS}}{0.5 \times V_{OUT}^2} \text{ (V/V)}$$

Where G_{CS} is the compensation voltage to inductor current gain, and the V_{FB} is the feedback regulation threshold.

There is also a right-half-plane zero (F_{RHPZ}) that exists in continuous conduction mode (inductor current does not drop to zero on each cycle) step-up converters. The frequency of the right half plane zero is:

$$F_{RHP} = \frac{R_{LOAD}}{2 \times \Pi \times L} \times \left(\frac{V_{IN}}{V_{OUT}}\right)^2 \text{ (Hz)}$$

The “Component Selection” table lists generally recommended compensation components for different input voltages, output voltages and capacitances of most frequently used output ceramic capacitors. Ceramic capacitors have extremely low ESR, therefore the second compensation capacitor (from COMP to GND) is not required.

Table 2—Component Selection

<u>V_{IN}</u> (V)	<u>V_{OUT}</u> (V)	<u>C_{OUT}</u> (μF)	<u>R_{comp}</u> (kΩ)	<u>C_{comp}</u> (nF)	<u>Switching Frequency</u> (kHz)	<u>Inductor</u> (μH)
3	12	4.7	10	6.8	600	8.2
3	12	10	15	6.8	600	8.2
3	12	22	30	6.8	600	8.2
5	12	10	12	4.9	600	6.8
5	12	22	25	4.9	600	6.8
5	18	4.7	12	4.9	600	10
5	18	10	25	4.9	600	10
5	18	22	50	4.9	600	10
12	24	4.7	10	6.8	600	10
12	24	10	20	6.8	600	10
12	24	22	40	6.8	600	10
12	48	4.7	30	4.7	600	33
12	48	10	60	4.7	600	33
12	48	22	60	10	600	33

For faster control loop and better transient response, set the capacitor C7 to the recommended value in the table. Then slowly increase the resistor R6 and check the load step response on a bench to make sure the ringing and overshoot on the output voltage at the edge of the load steps is minimal. Finally, the compensation needs to be checked by calculating the DC loop gain and the crossover frequency. The crossover frequency where the loop gain drops to 0dB (a gain of 1) can be obtained visually by placing a -20dB/decade slope at each pole, and a +20dB/decade slope at each zero. The crossover frequency should be at least one decade below the frequency of the right-half-plane zero at maximum output load current to obtain high enough phase margin for stability.

Layout Considerations

High frequency switching regulators require very careful layout for stable operation and low noise. All components must be placed as close to the IC as possible. Keep the path between L1, D1, and C_{OUT} extremely short for minimal noise and ringing. C_{IN} must be placed close to the IN pin for best decoupling. All feedback components must be kept close to the FB pin to prevent noise injection on the FB pin trace. The ground return of C_{IN} and C_{OUT} should be tied close to the GND pin. See the MP3425 demo board layout for reference.

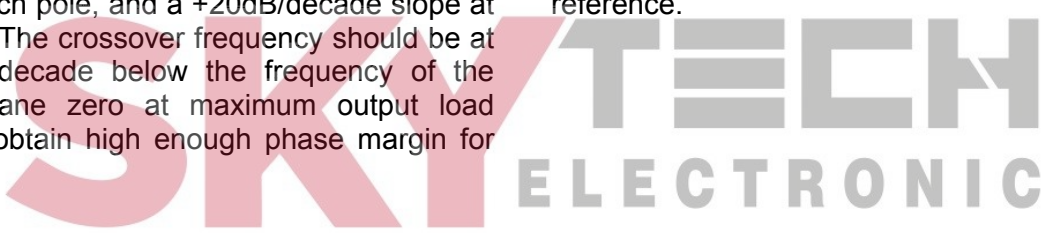

PACKAGE INFORMATION

QFN-14 (3mmx4mm)

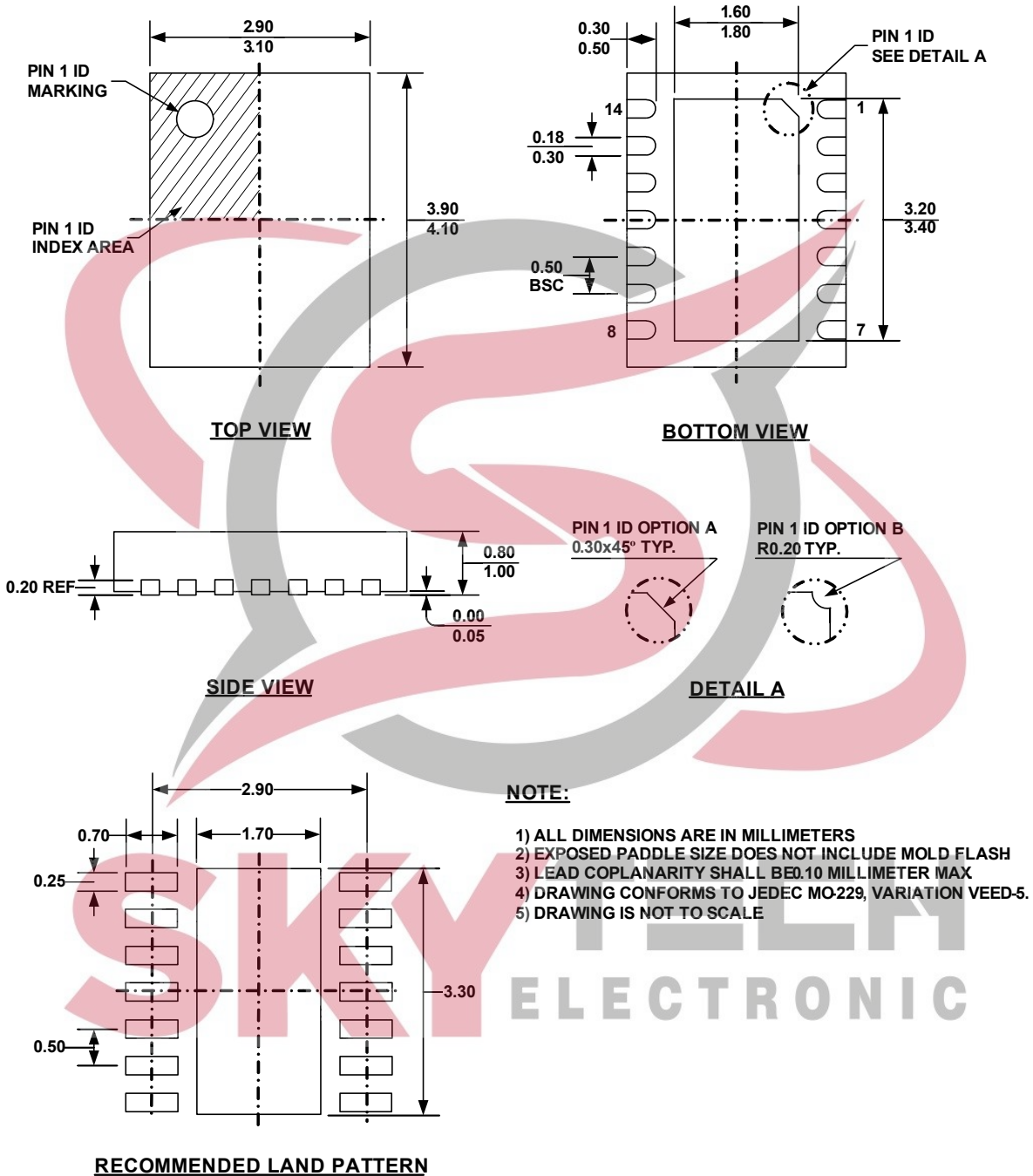

NOTE:

- 1) ALL DIMENSIONS ARE IN MILLIMETERS
- 2) EXPOSED PADDLE SIZE DOES NOT INCLUDE MOLD FLASH
- 3) LEAD COPLANARITY SHALL BE 0.10 MILLIMETER MAX
- 4) DRAWING CONFORMS TO JEDEC MO-229, VARIATION VEED-5.
- 5) DRAWING IS NOT TO SCALE

NOTICE: The information in this document is subject to change without notice. Users should warrant and guarantee that third party Intellectual Property rights are not infringed upon when integrating MPS products into any application. MPS will not assume any legal responsibility for any said applications.